

OWNER'S MANUAL

MAGNAVOX
SMART. VERY SMART.

MPD720
PORTABLE DVD PLAYER



THANK YOU FOR CHOOSING MAGNAVOX.

NEED HELP FAST?

READ YOUR QUICK-USE GUIDE AND/OR OWNER'S MANUAL FIRST FOR QUICK TIPS THAT MAKE USING YOUR MAGNAVOX PRODUCT MORE ENJOYABLE. IF YOU HAVE READ YOUR INSTRUCTIONS AND STILL NEED ASSISTANCE, YOU MAY ACCESS OUR ONLINE HELP AT WWW.MAGNAVOX.COM OR CALL **1-800-705-2000** WHILE WITH YOUR PRODUCT.

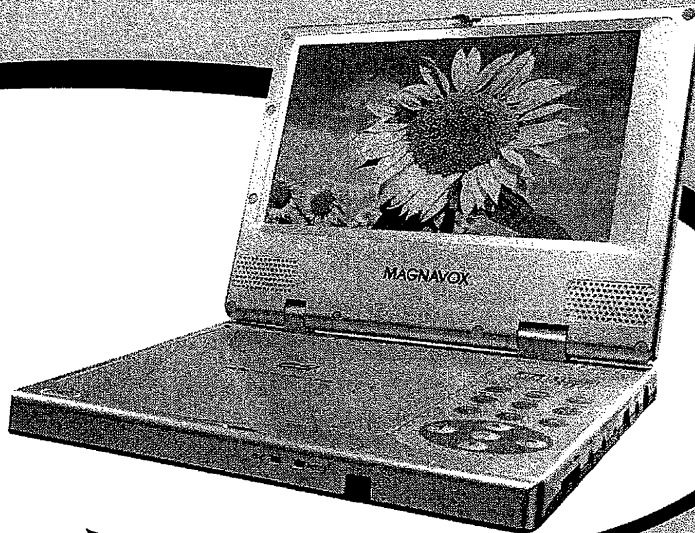

Return your Product Registration Card today to get the very most from your purchase.

Registering your model with MAGNAVOX makes you eligible for all of the valuable benefits listed below, so don't miss out. Complete and return your Product Registration Card at once to ensure:

*Proof of Purchase

Returning the enclosed card guarantees that your date of purchase will be on file, so no additional paperwork will be required from you to obtain warranty service.

*Product Safety Notification

By registering your product, you'll receive notification - directly from the manufacturer - in the rare case of a product recall or safety defect.

*Additional Benefits of Product Ownership

Registering your product guarantees that you'll receive all of the privileges to which you're entitled, including special money-saving offers.

MAGNAVOX

*Congratulations on your purchase,
and welcome to the "family!"*

Dear MAGNAVOX product owner:

Thank you for your confidence in MAGNAVOX. You've selected one of the best-built, best-backed products available today. We'll do everything in our power to keep you happy with your purchase for many years to come.

As a member of the MAGNAVOX "family," you're entitled to protection by one of the most comprehensive warranties and outstanding service networks in the industry. What's more, your purchase guarantees you'll receive all the information and special offers for which you qualify, plus easy access to accessories from our convenient home shopping network.

Most importantly, you can count on our uncompromising commitment to your total satisfaction.

All of this is our way of saying welcome - and thanks for investing in a MAGNAVOX product.

P.S. To get the most from your MAGNAVOX purchase, be sure to complete and return your Product Registration Card at once.

Know these
safety symbols



 This "bolt of lightning" indicates uninsulated material within your unit may cause an electrical shock. For the safety of everyone in your household, please do not remove product covering.

The "exclamation point" calls attention to features for which you should read the enclosed literature closely to prevent operating and maintenance problems.

WARNING: To reduce the risk of fire or electric shock, this apparatus should not be exposed to rain or moisture, and objects filled with liquids, such as vases, should not be placed on this apparatus.

CAUTION: To prevent electric shock, match wide blade of plug to wide slot, fully insert.

ATTENTION: Pour éviter les choc électriques, introduire la lame la plus large de la fiche dans la borne correspondante de la prise et pousser jusqu'au fond.

For Customer Use

Enter below the Serial No. which is located on the rear of the cabinet. Retain this information for future reference.

Model No. _____

Serial No. _____

MAGNAVOX

Visit our WorldWide Web Site at <http://www.magnavox.com>

IMPORTANT SAFETY INSTRUCTIONS

1. Read these instructions.

2. Keep these instructions.

3. Heed all warnings.

4. Follow all instructions.

5. Do not use this apparatus near water.

6. Clean only with dry cloth.

7. Do not block any ventilation openings. Install in accordance with the manufacturer's instructions.

8. Do not install near any heat sources such as radiators, heat registers, stoves, or other apparatus (including amplifiers) that produce heat.

9. Do not defeat the safety purpose of the polarized or grounding-type plug.

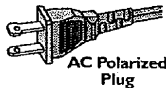

A polarized plug has two blades with one wider than the other. A grounding type plug has two blades and a third grounding prong. The wide blade or the third prong are provided for your safety. If the provided plug does not fit into your outlet, consult an electrician for replacement of the obsolete outlet.

10. Protect the power cord from being walked on or pinched, particularly at plugs, convenience receptacles, and the point where they exit from the apparatus.

11. Only use attachments/accessories specified by the manufacturer.



12. Use only with the cart, stand, tripod, bracket, or table specified by the manufacturer or sold with the apparatus. When a cart is used, use caution when moving the cart/apparatus combination to avoid injury from tip-over.

13. Unplug this apparatus during lightning storms or when unused for long periods of time.

14. Refer all servicing to qualified service personnel. Servicing is required when the apparatus has been damaged in any way, such as power-supply cord or plug is damaged, liquid has been spilled or objects have fallen into the apparatus, the apparatus has been exposed to rain or moisture, does not operate normally, or has been dropped.

15. Battery usage **CAUTION** – To prevent battery leakage which may result in bodily injury, property damage, or damage to the unit:

- Install **all** batteries correctly, + and - as marked on the unit.
- Do not mix batteries (**old** and **new** or **carbon** and **alkaline**, etc.).
- Remove batteries when the unit is not used for a long time.

16. Apparatus shall not be exposed to dripping or splashing.

17. Do not place any sources of danger on the apparatus (e.g. liquid filled objects, lighted candles).

18. This product may contain lead and mercury. Disposal of these materials may be regulated due to environmental considerations.

For disposal or recycling information, please contact your local authorities or the Electronic Industries Alliance : www.eiae.org.

EL 6475-E005: 04/01

Safety Precautions

Power Sources

This unit operates on a supplied AC adaptor, car adaptor, or a rechargeable battery pack.

- Make sure that the input voltage of the AC adaptor is in line with the local voltage. Otherwise, the AC adaptor and unit may be damaged.
- Do not touch the AC adaptor with wet hands to prevent electric shock.
- When connecting with car power (cigarette lighter) adaptor, be sure the input voltage of the adaptor is identical with car voltage.
- Unplug the AC adaptor from the outlet or remove the battery pack when the unit is not used for long periods of time.
- Hold the plug to disconnect the AC adaptor. Do not pull the power cord.

On Placement

Avoid placing the unit in the following places.

- Under direct sunlight or near a source of heat such as a heater.
- Never leave the unit in a closed automobile, on a dashboard or an unstable shelf. Excess heat may deform the cabin or cause malfunction.
- Where it is very dusty or sandy.
- Wet or humid places, such as bathroom.
- Near sources of strong magnetism, such as a television, speaker, or magnet.
- Where there is a lot of movement or vibration, such as on a car dashboard or an unstable shelf.
- Where it is extremely hot or cold.
- Where the unit is exposed to rain or water.

For Safety

- Do not disassemble the unit for laser rays are dangerous to eyes. Any service should be done by qualified service personnel.

- Unplug the AC adaptor to cut the power if liquid or objects get inside the unit.
- Take care not to drop the unit or subject it to strong shocks, which may cause malfunction.

Note: When the player is in use for a long period of time, the surface will be heated. This is normal.

Maintenance

- Do not touch the lens !



- If the player is brought directly from a cold to a warm location, or is placed in a very damp room, moisture may condense on the lens inside the player. If this occurs, the player will not operate normally. Leave the power on for about one hour with no disc in the disc tray until normal playback is possible.
- Avoid dust. Keep the disc tray closed after use. If there is dust on the lens, use a cleaning disc to clean.

Handling discs

- Do not attach paper or tape to the disc.
- Keep the disc away from direct sunlight or heat sources.
- Store the disc in a disc case after playback.
- To clean, wipe the disc outwards from the center with a soft, lint-free clean cloth.



Contents

Important Safety Instructions	3
Safety Precautions	4
About MPD720	6
Controls	
Main Unit	7
Remote Control.....	8
Power Supply	
Using the AC power adaptor	9
Using the battery pack	10
Using the remote control.....	12
General disc information, About ⊙	13
Basic Operations	
Playback	14
Language & channel select, DVD Menu Play, Pause	15
Fast Searching, Slow Play	16
Repeat	17
Shuffle, Random, Digest	18
Bookmark, Zoom, Scanning CDs	19
Subtitles, Angles	20
Using TIME SEARCH	21
Programming DVD and CD tracks	22
MP3 Operation and Viewing JPEG files	23
OSD: On-screen Display features	
General OSD Operations, Title, Chapter	24
Language, Subtitles	25
Angle, TT Time, CH Time, Repeat	26
Time Display, Playing CDs	27
Setup Menu functions	
General Setup Menu operation.....	28
General Setup:TV Display	29
SPDIF, Captions, Screen Saver, Audio Setup	30
Speaker Setup, Dolby submenus	31
3D Processing, LCD, Password Setup.....	32
Preference Page: Default, Parental	33
Connecting to additional equipment	34
Technical Specifications	37
Troubleshooting	38
Limited Warranty	40

About MPD720

High Definition

The player adopts MPEG2 coding format and brings the horizontal resolution over 500 lines.

Unique Functions

Multi-Angle and Multi-Language capability. Parental lock makes it easy to control the content of discs.

Zoom

You can enlarge pictures two or three or four times the original size. You can also shrink pictures by 25%-50%.

Multi - Functions

Fast forward, fast reverse, slow play, frame play, repeat play and program play.

Time Search

It can search a specific part on a disc, especially good for watching action movies.

Audio Output

Analog audio output or optical digital audio output enables you to connect to an amplifier to enjoy high quality sound effects.

Supplied accessories

Make sure these items are in the package. If any item is missing, please contact your dealer.

- 1 x Audio / Video cable
- 1 x Remote control
- 1 x Car adaptor
- 1 x AC power adaptor
- 1 x Rechargeable battery pack
- 1 x Warranty card
- 1 x User guide
- 1 x travel bag

About DVDs

• Title, Chapter

To help you skip and search content, the images or music of a DVD are divided into units. A title is made up of several chapters, and each chapter has a number for search (chapter numbering may not be available on all DVDs). Some DVDs may be structured with more than one title.

CAUTION

Use of controls or adjustments or performance of procedures other than herein may result in hazardous radiation exposure or other unsafe operation.

The set complies with the FCC-Rules, Part 15 and with 21 CFR 1040.10.

Operation is subject to the following two conditions:

- 1. This device may not cause harmful interference, and***
- 2. This device must accept any interference received, including interference that may cause undesired operation.***

Canada

English: This digital apparatus does not exceed the Class B limits for radio noise emissions from digital apparatus as set out in the Radio Interference Regulations of the Canadian Department of Communications.

Controls

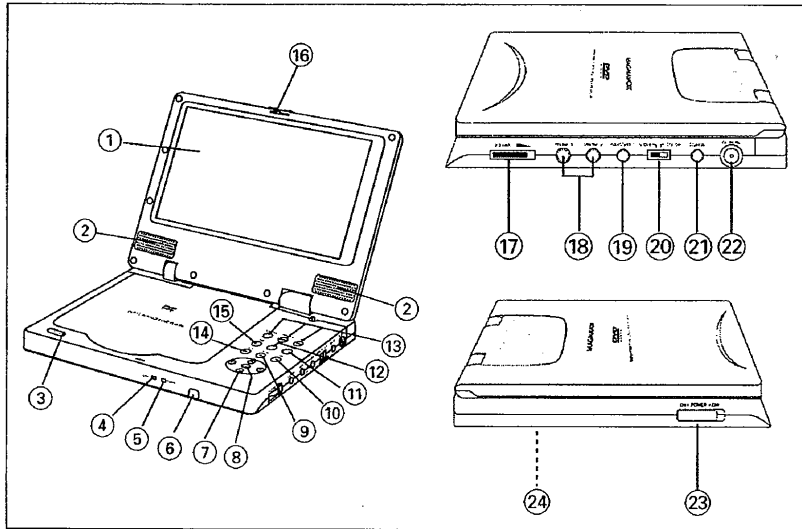

Main Unit

- | | | | |
|---|--------------------------------|---|--|
| ① | Display panel | ⑭ | ▶ (PLAY) |
| ② | Speaker | ⑮ | TITLE |
| ③ | OPEN | ⑯ | Lock - secures display panel close. Slide the display panel's OPEN switch to unlock. |
| ④ | CHG - battery charge indicator | ⑰ | VOLUME |
| ⑤ | POWER - power indicator | ⑱ | PHONE 1 & PHONE 2 |
| ⑥ | Infrared for remote control | ⑲ | AUDIO / VIDEO |
| ⑦ | Direction buttons: ▲, ▼, ►, ◀ | ⑳ | TV OUT / TFT ON |
| ⑧ | OK | ㉑ | COAXIAL (DIGITAL AUDIO OUTPUT) |
| ⑨ | ▬ (PAUSE) | ㉒ | DC IN 9V |
| ⑩ | ■ (STOP) | ㉓ | ON (POWER) OFF |
| ⑪ | RETURN | ㉔ | Type plate |
| ⑫ | MENU | | |
| ⑬ | FUNCTION & ⏪/⏩ | | |

✓ TIP:

* Do not adjust the **TV OUT/TFT ON** switch at random. Keep the **TV OUT/TFT ON** switch in the **TFT ON** position when the **POWER** switch is set to ON.

Remote Control

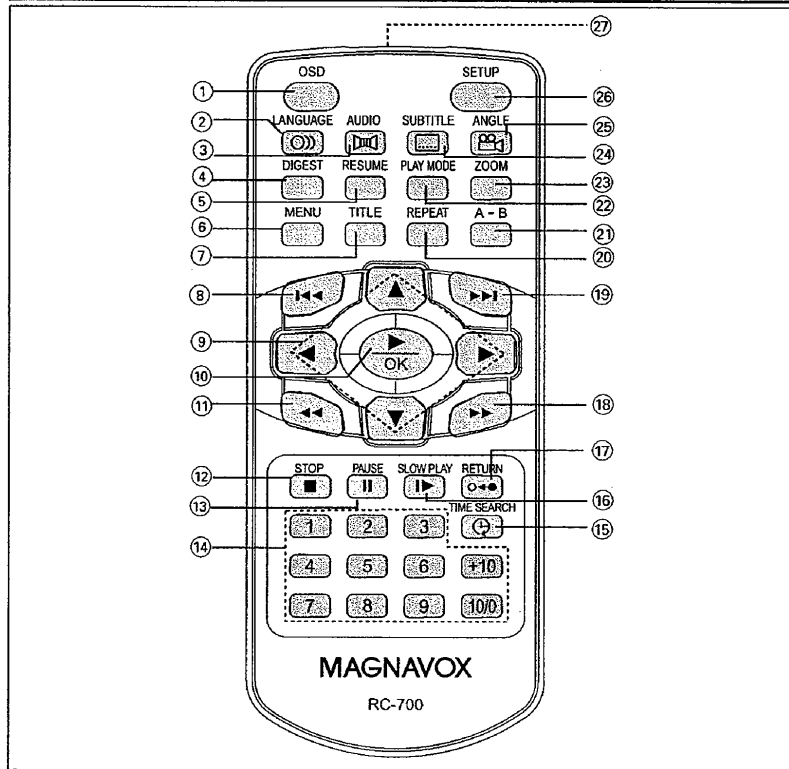

- | | | | |
|---|-------------------------------|---|-----------------------|
| ① | OSD (On-Screen Display) | ⑭ | Number buttons |
| ② | ⓘ LANGUAGE | ⑮ | ⌚ TIME SEARCH |
| ③ | 🔊 AUDIO | ⑯ | ▶ SLOW PLAY |
| ④ | DIGEST | ⑰ | ⏪ RETURN |
| ⑤ | RESUME | ⑱ | ▶▶ |
| ⑥ | MENU | ⑲ | ▶▶ |
| ⑦ | TITLE | ⑳ | REPEAT |
| ⑧ | ⏪ | ㉑ | A-B |
| ⑨ | Direction buttons: ▲, ▼, ▶, ◀ | ㉒ | PLAY MODE |
| ⑩ | ▶ / OK | ㉓ | ZOOM |
| ⑪ | ⏪ | ㉔ | ⋮ SUBTITLE |
| ⑫ | ■ (STOP) | ㉕ | 📺 ANGLE |
| ⑬ | ⏸ (PAUSE) | ㉖ | SETUP |
| | | ㉗ | Remote control sensor |

Using the AC power adaptor

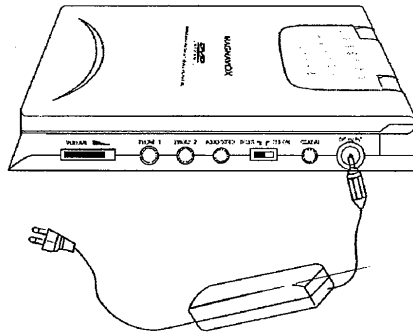

Connect to power

- 1 Connect the player's AC adaptor to the DC IN jack as shown.
- 2 Plug the AC adaptor into a power outlet.

 **TIP:**

Turn off the player before unplugging the AC adaptor so as to avoid damage to the player.

The type plate is located on the bottom of the player.

Using the Battery Pack

Attach the battery pack properly following the explanation below. Make sure that the battery pack is attached firmly to the player when using it. Otherwise, the battery may become detached and cause injury or damage. Charge your battery before using.

Attaching the Battery Pack

Disconnect the AC adaptor and the power cord from the player, before you attach the battery pack.

- 1 Turn the player off.
- 2 Turn the player upside down.
- 3 Insert the battery pack's catches into the player's corresponding holes. Then, slide the battery pack until it is attached firmly.



TIP:

Remove the battery pack from the player when not in use.

Detaching the Battery Pack

- 1 Turn the player off.
- 2 Disconnect the AC adaptor and the power cord from the player.
- 3 Turn the player upside down.
- 4 Slide the battery pack's lock switch, then slide off the battery pack as shown.

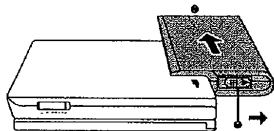

Charging the Battery Pack

We recommend you charge in room temperature (68°F) conditions. Never dispose of in fire or water.

- 1 Turn the player off.
- 2 Attach the battery pack to the player.

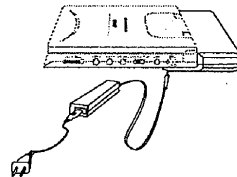

- 3 Connect the supplied AC adaptor and the power cord to the player. When charging starts, the **CHG** indicator illuminates red. When charging is completed, the **CHG** indicator turns off.

TIP:

When charging is in progress, do not disconnect the AC adaptor and the power cord until the **CHG** indicator turns off.

- When the player is turned off, the charging time is approximately **3-4** hours (depending on environmental conditions).
- The attached battery pack may become warm when you are charging it or operating the player. This is normal.
- A battery icon  is shown on the screen when battery power pack is running low.

Using the Battery Pack

Power shutdown mode

The power circuit in your player is designed with a power shutdown mode. This is activated only **during battery power operation of the player when the battery becomes completely drained**. When this happens:

- 1 Adjust the **POWER** switch on the player to the **OFF** position.
- 2 Connect your player to the AC power with the supplied power adaptor.
- 3 Let the player stand idle for 30 seconds before switching on again to resume disc operation on AC power supply.

Playback time

Times shown are approximate. Actual times depend on operating conditions.

Player on, LCD display on	2.5 hr.
Player on, LCD display off	4 hr.

Safety

- Do not use in high temperature or near heat sources.
- Never connect the positive and negative poles with metal.
- Do not open the battery, refer servicing only to qualified service personnel.

BATTERY DISPOSAL CAUTION:

Batteries contain chemical substances, so they should be disposed of properly. Dispose in accordance with applicable local, state/provincial or federal regulations.

Using the remote control

- 1 Please remove the protective plastic tab (on top of the battery inside the battery compartment) if you have just unpacked the remote control and are using for the first time.
- 2 To use the remote control, point it at the infrared sensor on the player's front panel avoiding obstacles.

✓ **TIP:**

To avoid interference with other electrical equipment, try using the remote control with a minimum distance of 7 inches from the sensor on the player.

Inserting battery for the remote control

- 1 Refer to the above diagram to open the battery compartment of the remote control. Insert 1 x lithium 3V battery, type CR2025, then close the compartment.
- 2 Remove the battery if the remote control is not used for long periods of time.

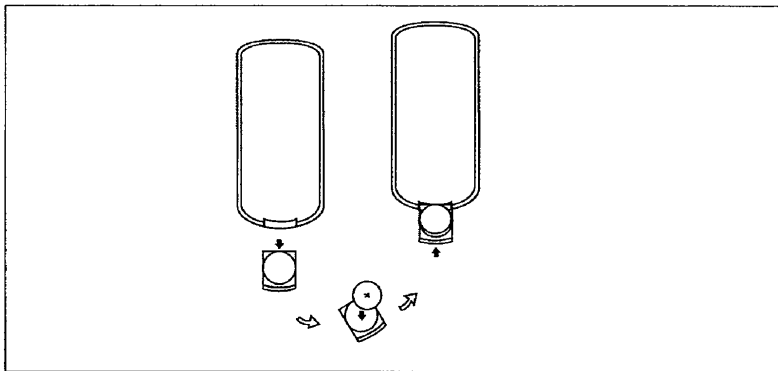



✓ **TIP:**

Generally, batteries last for about one year. Replace the batteries if the remote control does not work.



Batteries contain chemical substances, so they should be disposed of properly.

General disc information, About

Playable Discs

TYPE	DISC: LOGO	CONTENT	SIZE	PLAYING TIME
DVD		audio video (motion pictures)	12CM	about 2hrs (single-side disc) about 4hrs (double-side disc)
			8CM	about 80 mins (single-side disc) about 160 mins (double-side disc)
			12CM	about 74 mins
			8CM	about 20 mins
MP3		audio	8CM	about 600 mins

- The marks shown in the following chart are used in the manual.

MARK	INDICATION
	functions of DVD
	functions of CD

When Playing DVDs

Many DVD discs have the following playback features: Title, Chapter, Audio, Subtitle, Angle, TT (Title) Time, CH (Chapter) Time, Repeat, and Time Display.

About

All the features described in this manual may not be available on every disc. If the feature is not available on the disc, you will be unable to operate the feature on the player, and the icon  appears on the screen.

This can also happen when you try to play a feature that is not immediately available. For example, some features are enabled only during disc playback, while others are possible only if playback is stopped.

- Try stopping or starting playback, then try the feature again.

Basic Operations: Playback

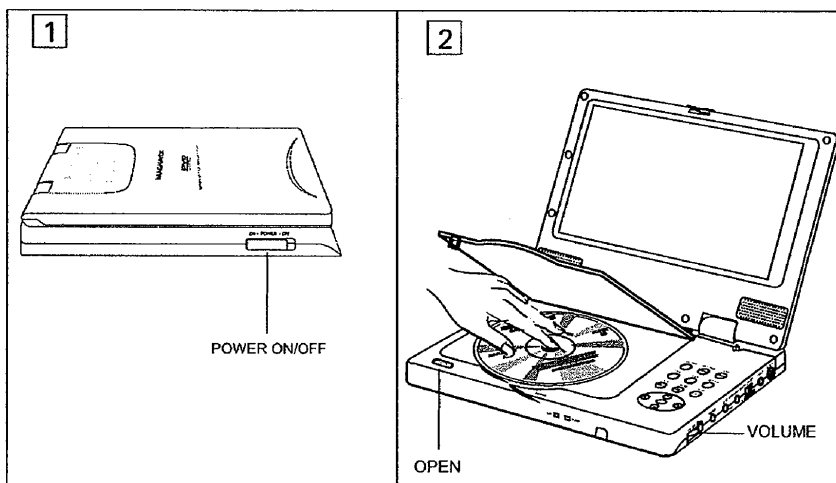

Before you begin, turn on the power of your TV, stereo, and any other equipment connected to the DVD Player. Make sure the TV and the stereo (if applicable) are set to the correct channel.

- 1** Slide the **POWER** switch to **ON** to turn on the player.
- 2** Press **OPEN** to open the disc tray.
- 3** Place a disc into the tray. If the DVD is recorded on only one side, place the disc in the tray with the label facing up and the shiny side facing down. Some DVDs are recorded on both sides. Make sure the label of the side you want to play is facing up.
- 4** Press the tray door down to close the tray.
- 5** To start playback, press ► (PLAY) /OK.
- To play MP3 CDs, see page 23.
- 6** Adjust the volume by using the **VOLUME** control.
- 7** To stop playback, press ■ (STOP) once. Pressing ■ (STOP) twice stops resume.
- 8** Slide the **POWER** switch to **OFF** to turn off the player.

✓ **TIP:**

During operation of the player you may hear a mechanical noise. This is normal.

Language & channel select, DVD Menu Play, Pause

DVD Language selection

Different discs differ in languages. You can select a language in a variety of ways:

- Using the OSD to enter the **Audio** submenu to select. If a language is included from this **Audio** submenu:

English
French
Spanish
Chinese
Japanese

is recorded on the disc, you can select sounds, subtitles or disc menu languages. If not, the language recorded on the disc is shown.

- Press **LANGUAGE** , the screen shows in sequence

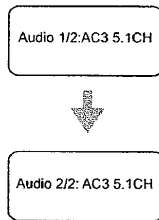

Channel select (for DVDs & CDs)

You may select the right channel or left channel or stereo from a multi-channel disc.

- Press **AUDIO** , the screen shows in sequence:

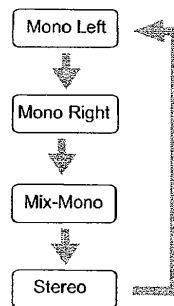

Some DVDs have title menus and chapter menus.

- Press **▶** (PLAY)/**OK**, to start playback Menu.
 - Press **▶▶** or **◀◀**, to skip the next or previous title/chapter.
 - Press the number buttons to select another title/chapter.
- Press **TITLE/ MENU** once or more to return to the respective menu / resume playback.

Pause and Frame-by-frame Playback (for DVDs only)

- During playback, press **⏸** (PAUSE). Play will pause and the sound will be mute.
 - When playing a DVD, press **⏸** (PAUSE) repeatedly to see the picture advance one frame at a time. The sound will remain mute.
- Pressing **⏸** (PAUSE) repeatedly during Audio CD, MP3, or JPEG playback will have no effect.
- Press **▶** (PLAY)/**OK** to resume normal playback.

Fast Searching

Fast Searching

- 1 Press ►► to play fast forward. Each time you press the button repeatedly, the screen shows in sequence:

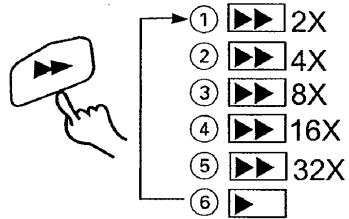

- 2 Press ◀◀ to fast reverse the disc. Each time you press the button repeatedly, the screen shows in sequence:

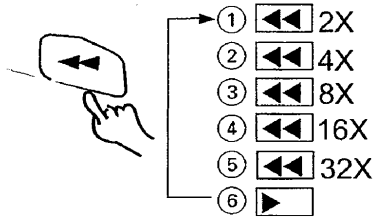

- 3 Press ► (PLAY)/OK to resume normal playback.

Slow Play

SLOW PLAY (DVDs only)

You can enjoy scenes in slow motion.

SLOW PLAY

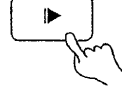

- 1 Press **SLOW PLAY** repeatedly to select a slow play option. The screen shows in sequence.

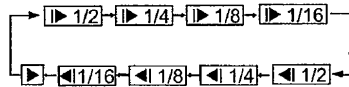

- 2 Press ► (PLAY)/OK to resume normal playback.

Repeat play options

Repeat Play

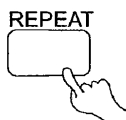

This button can be used to repeat a title, chapter, track, disc, or a specific portion of a disc.

DVD and CD repeat options

You may repeat a title or chapter.

- 1 To repeat a chapter, press **REPEAT**.

The screen will show

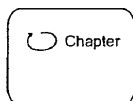

- 2 To repeat a title, press **REPEAT** again.

The screen will show



- 3 Repeat all:
Press **REPEAT** several times.

The screen shows "  ALL".

To cancel repeat playback

- Press **REPEAT** again until "  ALL" disappears.

Repeating selective segments

You may press **A-B** to play selective segments repeatedly.

- 1 Press **▶ (PLAY)/OK** to start disc playback.
- 2 When the disc reaches the point where you want repeated playback to begin, press **A-B**.

The screen shows:

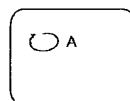

- 3 When the disc reaches the point where you want to end the segment, press **A-B** again. The segment will begin playing repeatedly.

- On a DVD, make sure the entire A-B segment is within a single Chapter. On a Video CD or Audio CD, the A-B segment should be within a single track.

The screen shows:

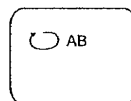

To cancel and resume normal playback

- Press **A-B** again until "  A B " disappears.

Shuffle, Random

Shuffle or Random Play

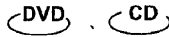

Both the Shuffle and Random options allow you to play the contents of your disc in a different order.

- 1 In disc stop position, press **PLAY MODE** once or more to select shuffle or random play mode.

PLAY MODE

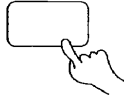

The screen shows Shuffle or Random:

- 2 Press **▶ (PLAY)/OK** to start shuffle or random play.

To cancel shuffle or random play

- Press **■ (STOP)**.

Digest Play

Use this function to scan through the title/chapter content of the track or disc.

DIGEST

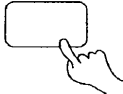

Example : Selecting **Chapter Digest**

- 1 During playback press **DIGEST**.

Digest

The screen shows:

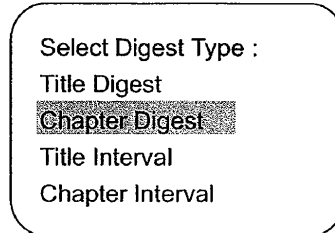

Use the **▼** or **▲** buttons to select "Chapter Digest" and press **▶ (PLAY)/OK** to confirm.

The player begins to look through the chapters, and shows the starting picture of each chapter on the screen.

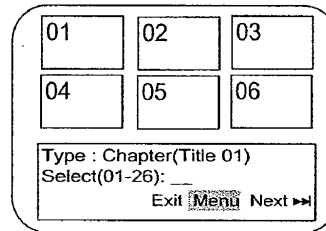

- 2 Use the direction buttons to select **NEXT ▶▶** on the screen, and press **▶ (PLAY)/OK** to go to the next page.

- 3 To cancel the digest feature, use the direction buttons to select **Exit** on the screen and press **▶ (PLAY)/OK** to confirm.

TIP :

If you have stored bookmarks on a DVD disc, there will be one more digest option:

Bookmark Digest.

Bookmark

Bookmark (DVD)

The bookmark feature lets you mark a point on the disc that you can go to quickly. You can store up to 12 bookmarks per disc. When you turn the player off or remove the disc, bookmarks are cleared.

Creating a Bookmark

- 1 During playback, press **RESUME** on the remote.
→The **Bookmark Menu** appears.
- 2 When you reach the scene you want to mark, press **▶ (PLAY)/OK**.
- 3 If you want to mark another point, press **▶** the button to move the cursor to next spot. When you reach another scene you want to mark, press **▶ (PLAY)/OK**.
→press **RESUME** to close the Bookmark Menu and resume to normal playback.

Using a Bookmark

- 1 During playback, press **RESUME**.
→The **Bookmark Menu** appears.
- 2 Use the direction buttons to highlight the bookmarked scene you want to play.
- 3 Press **▶ (PLAY)/OK** to go to the place you marked.

Zoom, Scanning CDs

Zoom Play (DVD)

This function can be used to watch a motion or still picture. The player has 3 zoom in 2X, 3X, 4X and 3 zoom out views 1/2, 1/3, and 1/4.

- 1 Press **ZOOM** during playback.

The screen shows:
Your picture is enlarged twice the original size.

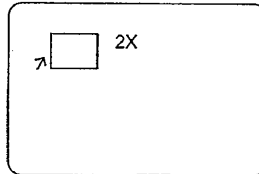

- 2 Press **ZOOM** repeatedly to further enlarge by 3 times (3X) or 4 times (4X).
- 3 For zoom out views only press **◀, ▲, ▼, ▶** to move the enlarged picture.
- 4 To cancel zooming, press repeatedly **ZOOM** until the picture is in normal size.

Scanning CDs

- 1 In stop mode, press **DIGEST**

The screen shows:

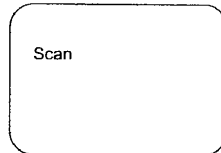

→The player scans first ten seconds of each track.

To cancel Scanning and playback :

- press **■ (STOP)**.

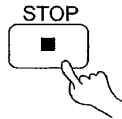

Subtitles

Selecting DVD Subtitles

This operation works only with discs on which multiple subtitle language are recorded.

- 1 Press **SUBTITLE**  repeatedly until the desired language is selected.

The screen shows :

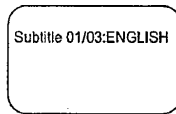

To cancel subtitle :

- Press **SUBTITLE**  repeatedly until the screen shows "Subtitle Off"

TIP :

- For some discs subtitles cannot be removed.
- Different discs differ in the language of subtitles.

Angles

Angles

Some discs have images with a number of different viewing angles. For example, when you watch a running train, you may watch it from the front, the left window or the right window without stopping it.

Example:

If DVD has four viewing angle options.

- 1 Press  to select ANGLE1.

SCREEN :

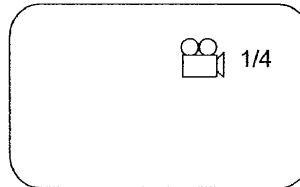

- 2 Press  repeatedly to select other angles, the screen shows respectively:

 2/4 (select ANGLE2)

 3/4 (select ANGLE3)

 4/4 (select ANGLE4)

- 3 To resume normal playback, press .

Using TIME SEARCH

With this button, you can toggle between 3 TIME SEARCH options. You may directly enter a time, title or chapter number to fast search on a disc, and play from that point.

How to search a DVD title or a chapter

For example: Searching to chapter 2 in title 6.

1 Press **TIME SEARCH**.

The screen shows:

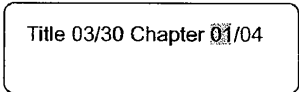

Title 03/30 Chapter 01/04

2 Press a direction button and move the cursor to highlight the title number.

The screen shows:

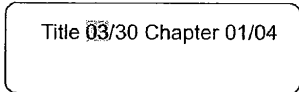

Title 03/30 Chapter 01/04

3 Press button **6** to select title 6.

The screen shows:

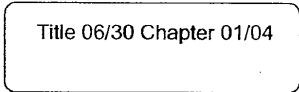

Title 06/30 Chapter 01/04

4 Repeat the steps above, select chapter 2 in title 6.

Selecting to play your DVD from a specific elapsed playback time:

1 Press **TIME SEARCH** repeatedly until the screen shows :

Track : --/xx,

where xx denotes the total number of tracks on your CD.

→ CD playback will start from the selected track number.

Programming DVD and CD tracks

To use the program playback feature, you must enter the order in which you want the titles (and chapters) on the DVD or the tracks on the CD to play by creating a program. Program display options may vary according to your DVD and show **TT--** (Title) as well as **CH--** (Chapter).

DVDs

- 1 During playback press **PLAY MODE** once or more until the screen shows the program box. For example :

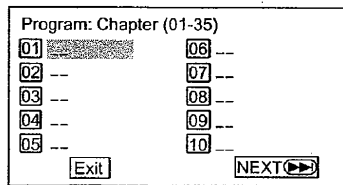

- 2 Use the number buttons on the remote to enter the chapter you want to play first.
→ The chapter number you entered appears in the box. The screen shows:

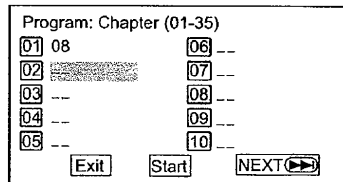

- The cursor jumps to the next spot in the program list section.
- 3 Make sure the box is highlighted and enter your next track.
 - 4 Continue adding chapters until your program is complete.

To playback a DVD/CD program :

You can play your program by highlighting **Start** and pressing ► (PLAY)/**OK**.

✓ TIP :

If the chapters or tracks you want to program are more than 10, you can highlight **NEXT** and press ► (PLAY)/**OK** to go to the next page.

To cancel a program

- Press ■ (STOP) until **Program :Off** appears.

CDs

- 1 Press **PLAY MODE** until the screen shows:

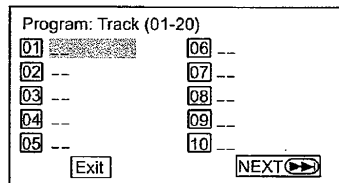

- 2 Use the number buttons on the remote to enter the track number you want in the box. The screen shows:

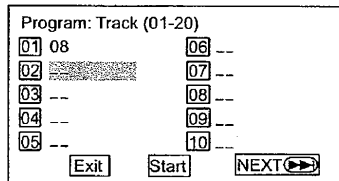

- The cursor jumps to the next spot in the program list section.
- 3 Make sure the box is highlighted and enter your next track.

Playing MP3 discs

Viewing JPEG files

MP3

Select Tracks with Menu

- 1 Insert a disc, the player reads the disc. The TV screen displays main menu.

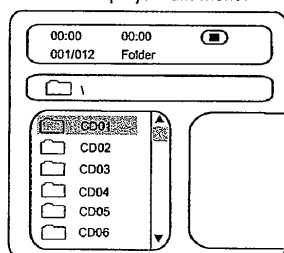

- 2 Press ▼ to select a music folder. Press ► (PLAY)/OK to confirm selection. Example: Select CD02 :

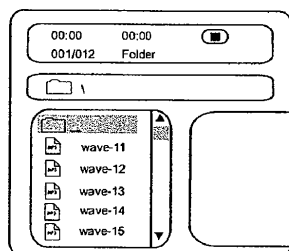

- 3 Use the direction buttons to select a track. Press ► (PLAY)/OK to start playback.
- 4 In stop mode, select the folder icon on the left side, then press ► (PLAY)/OK to return to the main menu.
- 5 Press ► or ◀ to play a previous or next track.

Programming MP3 tracks

- 1 In stop mode, press **PLAY MODE** once or more to bring up the filelist.
- 2 Use the direction button ▼ to select the songs which you want to be programmed. Press **RESUME** to confirm, and "**Add to Playlist**" will be displayed.
- 3 When your program is complete, press **PLAY MODE** again, "**Playlist**" will be displayed. Press ► (PLAY)/OK to start playback.

To cancel your program

- Your program is to start playback memorised by the player, and is deleted/cancelled when you remove your MP3 disc from the player.

Other MP3 functions

During playback MP3 discs, the unit features mute, volume control, repeat play and etc. Operations are the same as CD.

Viewing JPEG files

You can also view JPEG still photos on this player.

- 1 Insert a disc, the player reads the disc.
 - 2 Press ▼ to select a picture folder. Press ► (PLAY)/OK to confirm selection.
 - 3 Use the direction buttons to select a track. Press ► (PLAY)/OK to view a photo.
- If your folder contains more than one photo, the player will then automatically enter the slide show mode. Using the full display screen, this shows the rest of the JPEG files, one-by-one, located in the selected current folder.

General OSD Operations

OSD operation (for DVDs and CDs)

The On-Screen Display (OSD) contains many playback features.

- To see the OSD Menu, press the **OSD** button on the remote control while a disc is playing. During OSD Menu operation, your picture zooms out.
- Use the direction buttons **▲** or **▼** to move through the different playback features in the OSD Menu. When a playback feature is highlighted, press **▶** (PLAY)/**OK** and the box to the right will be highlighted.
- Use the direction buttons **▲** or **▼** to move through the choices.
- To return to the normal playback screen, press the **OSD** button.

OSD: Title, Chapter

Selecting Title

Some discs contain more than one title. Each title is divided into chapters. To select a title:

- 1** While the disc is playing, press **OSD** on the remote to bring up the Menu.
- 2** If "Title" on the Menu isn't highlighted, use the direction buttons **▲** or **▼** to highlight it.
- 3** Press **▶** (PLAY)/**OK**. The box to the right is will be highlighted.
- 4** Use the number buttons on the remote control to enter a title number that you want to play.

 **TIP:**

Some discs only have one title.

Selecting a Chapter

You can skip to a specific chapter by using the Chapter feature in the Menu.

- 1** While the disc is playing, press **OSD** on the remote to bring up the Menu.
- 2** Press the direction buttons **▲** or **▼** to highlight "Chapter".
- 3** Press **▶** (PLAY)/**OK**, the box to the right is will be highlighted.
- 4** Use the number buttons on the remote to enter a chapter number that you want to play.

 **TIP:**

The Chapter feature won't work if the disc isn't formatted with separate chapters. You can also advance to the next chapter by pressing **▶▶** on the remote control and go to the preceding chapter by pressing **◀◀**.

OSD: Language

Changing the Audio Language

If the disc was created with different language tracks (recorded in different languages), you can use the OSD Menu to temporarily change the DVD player's Audio Language setting.

- 1 While the disc is playing, press **OSD** on the remote control to bring up the Menu.
- 2 Press the direction buttons **▲** or **▼** to highlight "Audio".
- 3 Press **▶ (PLAY)/OK**, the audio languages appear on the screen.
- 4 Press the **▲** or **▼** to move through the audio languages that are available on the disc. Press the **▶ (PLAY)/OK** when the audio language you want to use is highlighted.

TIP:

The Language feature only works if the disc was created with multiple audio tracks. When you choose an audio language from the OSD Menu, you only override the audio language setting in the DVD player's main menu temporarily.

The audio language can also be changed through the DVD player menu.

Subtitles

Changing the Subtitle language

If the disc was created with different subtitles, you can use the OSD Menu to change the Subtitle language.

- 1 While the disc is playing, press **OSD** on the remote to bring up the Menu.
- 2 Press the **▲** or **▼** to highlight "Subtitle".
- 3 Press the **▶ (PLAY)/OK**, the subtitle languages appears.
- 4 Press **▲** or **▼** to move through the subtitle languages that are available on the disc. Press **▶ (PLAY)/OK** when the subtitle language you want to use is highlighted.

TIP:

- Changing the subtitle language with OSD will only affect the disc currently being played. When the disc is removed or the player is turned off, the subtitle language will revert to the language setting specified through the DVD player main menu.
- The subtitle language can also be changed by using the **SUBTITLE**  button (see page 20, **Selecting DVD Subtitles.**)

OSD: Angle, TT Time, CH Time, Repeat

Changing the Camera Angle

Some DVDs contain scenes recorded from different angles. The camera angle will not change if the DVD does not contain sequences recorded from different camera angles.

- 1 While the disc is playing, press **OSD** on the remote control to bring up the Menu.
- 2 Press **▲** or **▼** to highlight "**Angle**".
- 3 Press **▶** (PLAY)/**OK**, the box to the right is now highlighted.
- 4 Use the number buttons to enter an angle number that you want to play.

Setting TT (Title) Time

You can skip to a specific title time by using the **TT (Title) Time** feature in the Display.

- 1 While the disc is playing, press **OSD** on the remote control to bring up the Menu.
- 2 Press **▲** or **▼** to highlight "**TT (Title) Time**".
- 3 Press **▶** (PLAY)/**OK**, the box to the right is now highlighted.
- 4 Use the number buttons to enter a title time that you want to play.

Setting CH (Chapter) Time

You can skip to a specific chapter time by using the **CH (Chapter) Time** feature in the Menu.

- 1 While the disc is playing, press **OSD** on the remote control to bring up the Menu.
- 2 Press **▲** or **▼** to highlight "**CH (Chapter) Time**".
- 3 Press **▶** (PLAY)/**OK**, the box to the right is now highlighted.
- 4 Use the number buttons to enter a chapter time that you want to play.

Repeat

The default mode for the repeat feature is **Off**. There are three repeat options:

- **Chapter** - repeats the chapter that is playing
- **Title** - repeats the title that is playing
- **All** - repeats the disc that is playing
- **Off**

- 1 During playback, press **OSD** on the remote control to bring up the Menu.
- 2 Press **▲** or **▼** to highlight "**Repeat**".
- 3 Press **▶** (PLAY)/**OK**, the repeat options appears.
- 4 Press **▲** or **▼** to move through the repeat options. Press **▶** (PLAY)/**OK** when the repeat option you want to use is highlighted.
- 5 To cancel repeat :
 - Go to the Repeat feature in the Menu and select **Off**.

OSD: Time Display

Changing the Time Disp(Display)

You can change the time displayed on the screen: Title Elapsed, Title Remain, Chapter Elapsed and Chapter Remaining.

- 1 While the disc is playing, press **OSD** on the remote control to bring up the Menu.
- 2 Press **▲** or **▼** to highlight "Time Disp".
- 3 Press **▶** (PLAY)/**OK**, the time options appears.
- 4 Press **▲** or **▼** to move through the time options. Press **▶** (PLAY)/**OK** when the option you want to use is highlighted.

Changing the Displayed Time

You can changing the time displayed on the screen : **Single (Track) Elapsed Time**, **Single (Track) Remain Time**, **Total (Disc) Elapsed Time**, and **Total (Disc) Remain Time**.

- 1 While the disc is playing, press **OSD** on the remote control to bring up the Menu.
- 2 Press **▲** or **▼** to highlight "Time Disp".
- 3 Press **▶** (PLAY)/**OK**, the time options appears.
- 4 Press **▲** or **▼** to move through the time options. Press **▶** (PLAY)/**OK** when the option you want to use is highlighted.

Playing CDs

CD discs have the following playback features: Track, Disc Time, Track Time, Repeat, and Time Display.

Selecting a specific track

- 1 While the disc is playing, press **OSD** on the remote control to bring up the Menu.
- 2 Press **▲** or **▼** to highlight "Track".
- 3 Press **▶** (PLAY)/**OK**, the box to the right is now highlighted.
- 4 Use the number buttons to enter a track number that you want to play.

Repeat

The default mode for the repeat feature is Off. There are two repeat options for CDs:

- All - repeats the disc that is playing
- Track - repeats the current track that is playing

- 1 While the disc is playing, press **OSD** on the remote control to bring up the Menu.
- 2 Press **▲** or **▼** to highlight "Repeat".
- 3 Press **▶** (PLAY)/**OK**, the repeat options appears.
- 4 Press **▲** or **▼** to move through the repeat options. Press **▶** (PLAY)/**OK** when the repeat option you want to use is highlighted.

General Setup Menu operations

Menu Setting

Functions may vary according to the Disc and your additional equipment such as connecting with speaker system. Set the following functions for the player to obtain the best viewing status.

- 1 Press **SETUP** to enter the Setup Menu.



The Setup Menu appears on the screen, with icons across the top of the screen, illustrating General Setup, Audio Setup, LCD Setup Page, Preference Setup, Password Setup, and Exit Setup.

The screen shows:

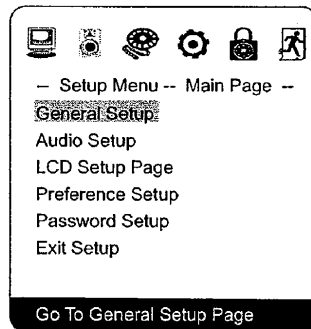

- 2 Press **▼** or **▲** to select your option and press **▶** (PLAY)/**OK** to confirm.

Example: Press **▼** to highlight **"Audio Setup"**, press **▶** (PLAY)/**OK** to enter **"Audio Setup Page"**

The screen shows:

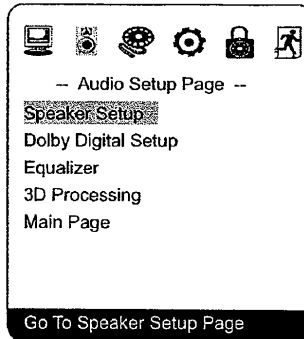

- Press **▼** or **▲** to highlight **"Dolby Digital Setup"**, and press **▶** (PLAY)/**OK** to enter **"Dolby Digital Setup"** page.

The screen shows the submenu:

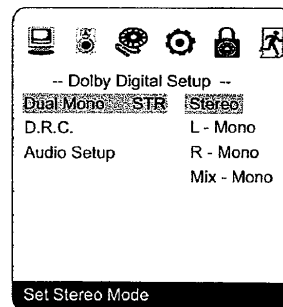

- Press **▶** or **▼** to select **"L - Mono"**.

The screen shows:

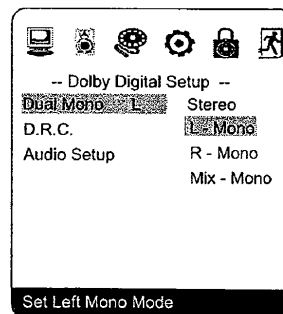

General Setup: TV Display

- Press ► (PLAY)/OK to confirm your selection.
- 3 To exit the Setup Menu, press ▼ to highlight "Exit Setup" and press ► (PLAY)/OK to exit Setup Menu completely.

TV Display Page

There are 3 TV display type options which you can select from the TV Display submenu on the **General Setup Page**.

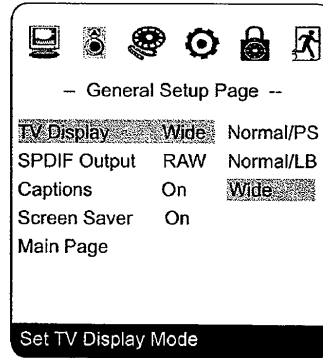

TV display type options as follows:

Normal/PS (Pan & Scan)

This is selected when the player is connected to a standard screen TV. Widescreen images are shown on the screen, but with some parts cut automatically.



SPDIF, Captions, Screen Saver, Audio Setup

Normal/LB (letterbox)

This is selected when the player is connected to a standard screen TV. Widescreen images are shown on the screen, with a black frame on the top and bottom.



Wide

This is selected when the player is connected to a widescreen TV.



TIP:

You can also press the **FUNCTION** button on the player to change the display mode between "4:3" and "16:9".

SPDIF Output

- **SPDIF OFF:** No signal is output from the digital port.
- **SPDIF/RAW:** Select this when the DVD player is connected with a digital amplifier through digital port. When a Dolby Digital disc or MPEG disc is played, the digital output will be optional. The power amplifier to be connected must have Dolby Digital and MPEG decoding.
- **SPDIF/PCM:** Select this when the DVD player is connected with a 2-channel digital stereo amplifier. When a Dolby Digital or MPEG disc is played, the digital port will output in PCM 2-channel format.

Captions (closed Captioning)

Screen captions are available only on DVDs and TVs encoded with the caption function. For DVDs which have captions, you will need to connect your player to your TV in order to select and enable the caption on/off option.

- **On**
The closed caption is shown.
- **Off**
The closed caption is turned off.

Screen Saver

When the screen saver is on, the screen saver image appears when the player stops or the image is frozen for a few minutes.

- **On:** Enables the screen saver.
- **Off:** Disables the screen saver.

Audio Setup

The submenu structure is:

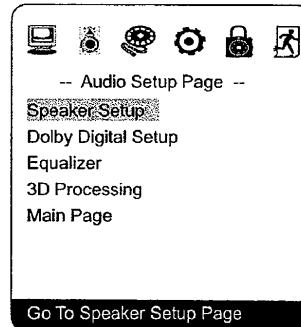

Speaker Setup, Dolby submenus

Speaker Setup Page

The submenu structure is:

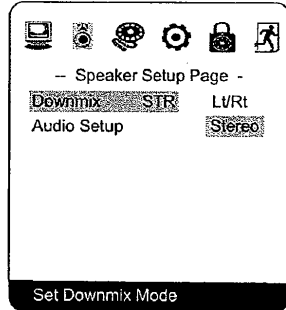

- **Lt/Rt**

The output signal will be incorporated to left and right channel.

- **Stereo**

The output signal will be incorporated to stereo.

Dolby Digital Setup Page

The submenu structure is:

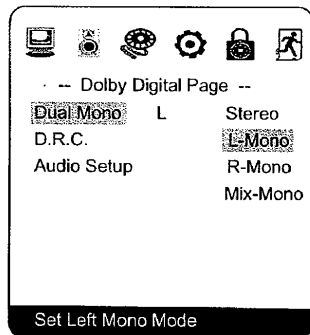

- **Dual Mono**

This is the output mode of the L and R signals of the set audio output. If it is set to "**Mix-Mono**", the function only works when the DVD being played is 5.1-channel.

- **D.R.C**

The **D**ynamic **R**ange **C**ompression (D.R.C.) is useful for nighttime viewing. DRC reduces the highs and lows by compressing and levelling out the volume range during disc playback.

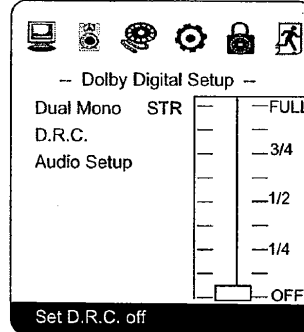

Equalizer Page

You can select graphic equalizer options according to the genre of the music being played.

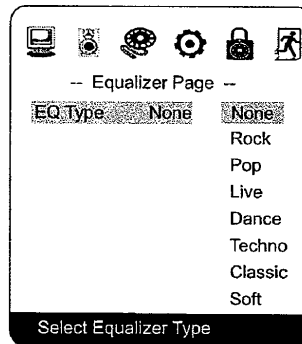

The setting structure is:

- Press ▲ or ▼ to select your EQ option.
Confirm by pressing ► (PLAY)/OK.

3D Processing, LCD, Password Setup

3D Processing Page

The submenu structure is:

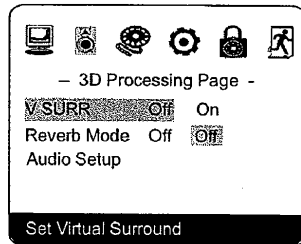

- **V SURR (Virtual Surround)**

You can select to turn the Virtual Surround sound on and off.

- **Reverb Mode**

Reverb Mode allows you to optimise sound effects. Select from 8 options, or none (off): **Off**, **Concert**, **Living Room**, **Hall**, **Bathroom**, **Cave**, **Arena** or **Church**

LCD Setup Page

The submenu structure is:

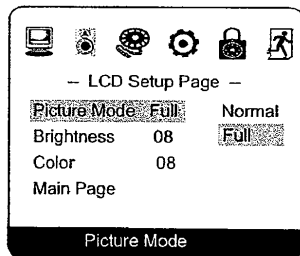

Picture Mode

- **Normal**
The picture is in normal size.
- **Full**
The picture will fit on full screen.

Brightness

You can use the ► or ◀ direction buttons to adjust the brightness.

Color

You can use the ► or ◀ direction buttons to adjust the color.

Password Setup Page

The submenu structure is:

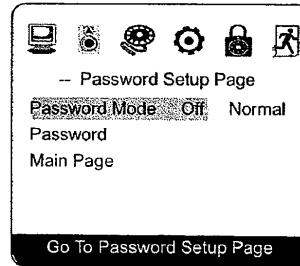

Password Mode

- **On**: password mode activated. "PARENTAL" is dimmed and cannot be selected.
- **Off**: The password is switched off, "PARENTAL" can be selected.

Changing your Password

Select the **Password** submenu to change the code. The screen shows:

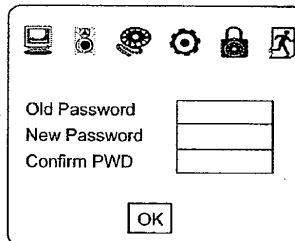

Follow the screen instructions to enter your password.



The default password is 99999

Preference Page: Default , Parental

The submenu structure is:

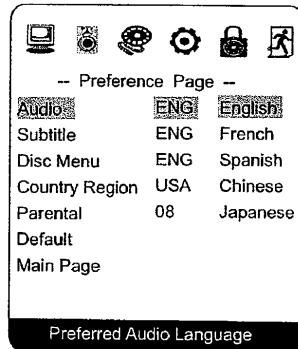

TIP:

The "**Preference Setup**" only can be selected when the player is in stop mode.

Default >> Reset

Each function setting returns to the default setting if you select this option.

Parental

With the parental lock function, you may select an age control rating for playback of discs on the player. For example, you can select and lock onto "PG", whereby you cannot play discs rated higher than PG. The DVD ratings available on this player are:

- 1 KID SAF
- 2 G
- 3 PG
- 4 PG 13
- 5 PGR
- 6 R
- 7 NC17
- 8 ADULT

How to set your Parental Lock Password

- 1 When in the disc stop position, press **SETUP** on the remote control to enter the "**Setup Menu - Main Page**".
 - 2 Press **▼** to highlight **Preference Setup**.
 - 3 Press the **▶** (PLAY)/**OK** to confirm and enter the **Preference Page**.
 - 4 Press **▼** to highlight **Parental**.
 - 5 Use the **▶** and the **▲** or **▼** to select your DVD rating. Press **▶** (PLAY)/**OK** to confirm.
- When a disc that is rated higher than the parental lock set rating is played, the security password will be required.

TIP:

- For security, when the Password is set **On** the parental lock function cannot be selected. You will need to switch your Password Off first (see page 32, **Password**)
- Some DVDs are not encoded with a rating, although the movie rating is printed on the disc case/packaging. The parental lock will not block viewing of such discs.
- Magnavox cannot guarantee the availability of parental control with all discs, and therefore denies any liability associated with unintended viewing.

Connecting to additional equipment

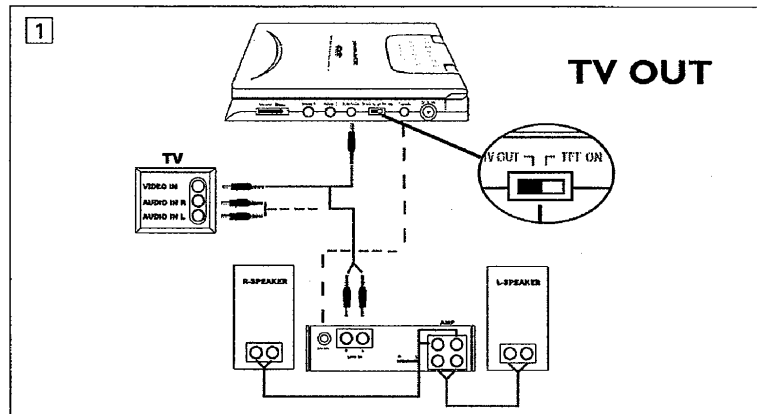

You can connect the player to a TV or an amplifier to enjoy DVDs or karaoke.

Connecting a TV and a Stereo/Amplifier (see 1)

- 1 Connect the yellow end of the supplied cable to the VIDEO IN jack of the TV. Connect the black end to the **AUDIO / VIDEO** jack on the player.
- 2 Connect the red end of same cable to the AUDIO IN R jack on the speaker. Connect the white end to the AUDIO IN L jack on the speaker.
- 3 Connect the AC adaptor into the **DC IN 9V** on the player. Connect the other end of the AC adaptor into a power outlet.

Using Headphones

- Insert headphones into the **PHONES** jack of the player.
- Turn off the power when inserting or disconnecting headphones.

Take care when using headphones

- **Hearing safety:** listen at a moderate volume. Using headphones at high volume can impair your hearing.
- **Traffic safety:** do not use while driving or cycling as you may cause an accident.

IMPORTANT!

MAKE SURE TV OUT / TFT ON IS AT THE TV OUT POSITION, OTHERWISE, THERE WILL BE NO DISPLAY ON YOUR TV!

Connecting to additional equipment

Connecting to a TV Only TV has only a single Antenna In or RF-In jack

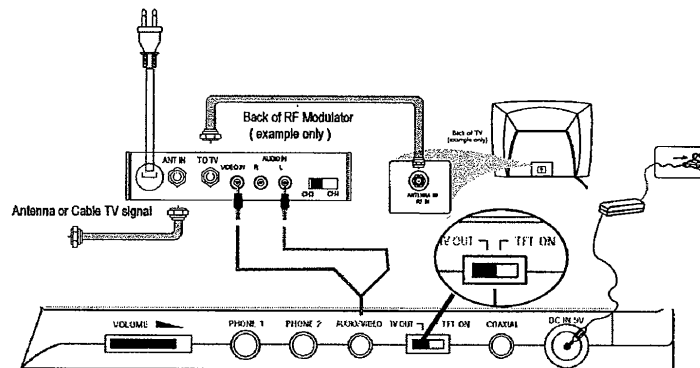

Before you begin, make sure you have an RF modulator and extra RF coaxial cables. These are not supplied with the player, but are available from Magnavox or most consumer electronics retailers.

- 1 Connect the black end of the supplied cable to the player's AUDIO / VIDEO jack. Connect the other yellow end to the VIDEO IN jack on the RF modulator.** The VIDEO IN jack on the RF modulator is usually yellow and might be labelled VIDEO, CVBS, COMPOSITE, or BASEBAND.
- 2 Connect the red end of the same cable to one of the AUDIO IN jacks on the RF modulator.** Audio jacks on the RF modulator usually are red (right) and white (left). Match the cable color to the jack color.
- 3 You probably already have an antenna or Cable TV signal connected to the ANTENNA IN jack on your TV. Disconnect it now from the TV. Reconnect the antenna or Cable TV signal to the ANTENNA IN jack on your RF modulator.**

IMPORTANT!

MAKE SURE TV OUT / TFT ON IS AT THE TV OUT POSITION. OTHERWISE, THERE WILL BE NO DISPLAY ON YOUR TV!

Connecting to additional equipment

- 4 Connect an RF coaxial cable (not supplied) to the RF OUT, ANTENNA OUT, or TO TV jack on the RF modulator.** The RF OUT jack may be labelled differently among different brands. Refer to the instructions provided with your RF modulator.

Connect the other end of the same RF coaxial cable to the ANTENNA IN or RF IN jack on your TV.
- 5** Your RF modulator should have a Channel 3/4 switch. The setting of this switch determines the TV channel on which you will watch materials playing on the DVD Player.

Set the RF modulator's Channel 3/4 switch to either 3 or 4, whichever TV channel is least used in your area. If your RF modulator has a modulator/antenna switch, set it accordingly. Refer to the instructions that came with the RF modulator.

Turn on your TV and choose channel 3 or 4. Choose the same channel to which you set the RF modulator's Channel 3/4 switch.
- 6 Connect the player's AC adaptor to a power outlet and turn on the DVD player's POWER switch to ON.** If no disc is in the player, you should see the player's screen saver on the TV screen.

Technical Specifications

Laser		wavelength 650nm
Video system		NTSC
Frequency response		20Hz ~ 20KHz \pm 1dB
Signal/noise ratio		\geq 85dB
Audio distortion + noise		\leq -80(1KHz)
Channel separation		\geq 85dB
Dynamic range		\geq 80dB
Output	Audio out (analog audio)	Output level: 2V \pm 10% Load impedance: 10K Ω
	Video out	Output level: 1Vp - p \pm 20% Load impedance: 75 Ω
Power supply		DC 9V 2.2A
Operating temperature range		32 ~ 122°F
Power Consumption		\leq 20W
Dimensions		7.48 x 5.75 x 1.14 (inches)
Weight		2.22 (lb)

Magnavox reserves the right to make design and specification changes for product improvement without prior notice.

This product incorporates copyright protection technology that is protected by method claims of certain U.S. patents and other intellectual property rights owned by Macrovision Corporation and other rights owners. Use of this copyright protection technology must be authorized by Macrovision Corporation, and is intended for home and other limited viewing uses only unless otherwise authorized by Macrovision Corporation. Reverse engineering or disassembly is prohibited.

Troubleshooting

If a fault occurs, first check the points listed below before taking the set for repair.

If you are unable to remedy a problem by following these hints, consult your dealer or service center.

WARNING:

Do not open the set as there is a risk of electric shock. Under no circumstances should you try to repair the set yourself, as this will invalidate the warranty.

No sound/power

- Check if the player is connected securely.
- Check volume on the player
- Disconnect headphone when not using headphone.
- Make sure you operate the TV or amplifier correctly.
- Make sure you have selected DVD player position on the amplifier.
- The power circuit in your player is designed with a power shutdown mode. This is activated only **during battery power operation of the player when the battery becomes completely drained**. When this happens:
 - 1 Adjust the **POWER** switch on the player to the **OFF** position.
 - 2 Connect your player to AC power with the supplied power adaptor.
 - 3 Let the player stand idle for 30 seconds **before** switching on again to resume disc operation on AC power supply.

Loud noise when operating the player

- This is normal and due to mechanical parts. Playback is not affected.

The player feels very warm

- When the player is in use for a long period of time, the surface will be heated. This is normal.

No picture

- Check if the player is connected securely.
- Make sure you operate the TV correctly.
- Make sure you set the color system correctly.

Bad sound quality

- Make sure the audio output mode is set correctly.
- Make sure you did not connect any cables from the DVD player to a Stereo's "PHONO IN" jack.
- Make sure you did not connect the player's COAXIAL digital audio out jack to an analog jack on the Stereo. (Analog audio jacks are usually labeled as such and are usually red and white. Coaxial jacks are usually black.)

Disc cannot play

- Check you have loaded a disc in the player if empty.
- Check you have loaded a disc properly with the label side up.
- Disc dirty/ damaged. Clean the disc.
- Moisture has condensed in the player. Remove the disc and leave the player to adjust to the surrounding temperature.

Remote control does not work

- Remove obstacles between the remote control and the player, and point directly instead of at a wide angle at the infrared sensor on the player.
- Battery maybe exhausted. Replace the battery with a new one.
- To avoid interference with other electrical equipment, try using the remote control with a minimum distance of 7 inches from the sensor on the player.

Troubleshooting

Image rolls and no color

- The color system of the player doesn't match your TV. Select the correct TV TYPE until your TV shows normal color.

An Audio CD will not play.

- Some Audio CDs available on the market are copy protected. These discs will not play on this DVD player. See your retailer for options regarding non-protected Audio CDs.

The DVD player will not select some features, such as Angles, Subtitles, or multi-language Audio.

- The feature may not be available on the disc. If it is not, the  will appear on the TV screen. Check the disc case to see if the disc has the feature. If the disc does not have the feature, the DVD player cannot create the feature. This is not a malfunction of the DVD player.

Or, the feature may not be available at the present time. Some features are only available during playback, while other items can be accessed only when play is stopped. Try stopping or starting playback, then try the feature again.

Disc play is irregular or DVD disc menu operation is faulty.

- Due to the inconsistency of disc formats provided by various disc manufacturers, your DVD player may require a playability enhancement or upgrade. As DVD technology has advanced, these enhancements have become both common and easy to complete. Please contact Magnavox at 1-800-705-2000 for assistance.

*For the latest product information & news visit :
<http://www.magnavox.com>*

Environmental information

We have done our best to reduce the packaging and make it easy to separate into 3 materials: cardboard, styrofoam, and plastic.

Your set consists of materials which can be recycled if disassembled by a specialized company. Please observe the local regulations regarding the disposal of packaging, dead batteries and old equipment.

LIMITED WARRANTY

PORTABLE DVD PLAYER

90 days Free Product Exchange / 91 days-One year Reduced-Cost Exchange

This product must be carried in for an exchange.

WHO IS COVERED?

You must have proof of the date of purchase to exchange your product. A sales receipt or other document showing the date that you purchased the product is considered such proof.

WHAT IS COVERED?

Warranty coverage begins the day you buy your product. For 90 days thereafter, you may exchange the defective product for a free new or renewed product through Magnavox.

From 91 days to one year from the date of purchase, you will pay a preset exchange fee to obtain a new or renewed product. Follow the exchange procedures on the next page. This exchange opportunity ends one year after the date of purchase. The replacement product is covered only for the warranty period of the original product. When the warranty on the original product expires, the warranty on all replaced products also expires.

When it is necessary for you to ship the product to Magnavox for exchange, you will pay the shipping costs for shipment to Magnavox. Magnavox will pay the shipping costs when returning a product to you.

WHAT IS EXCLUDED?

Your warranty does not cover:

- shipping charges to return defective product.
- labor charges for installation or setup of the product, adjustment of customer controls on the product, and installation or repair of antenna systems outside of the product.
- product repair and/or part replacement because of improper installation, abuse, neglect, misuse, accident, unauthorized repair or other cause not within the control of Magnavox.
- a product that requires modification or adaptation to enable it to operate in any country other than the country for which it was designed, manufactured, approved and/or authorized, or repair of products damaged by these modifications.
- incidental or consequential damages resulting from the product. (Some states do not allow the exclusion of incidental or consequential damages, so the above exclusion may not apply to you. This includes, but is not limited to, prerecorded material, whether copyrighted or not copyrighted.)
- a product used for commercial or institutional purposes (including but not limited to rental purposes).

WHERE IS EXCHANGE AVAILABLE?

Warranty exchange is available in all countries where the product is officially distributed by Magnavox. In countries where Magnavox does not distribute the product, the local Magnavox service organization will attempt to exchange the product, although there may be a delay if the appropriate product is not readily available.

MAKE SURE YOU KEEP...

Please keep your sales receipt or other document showing proof of date of purchase. Attach it to the owner's manual and keep both nearby. Also keep the original box and packing material in case you need to return your product.

BEFORE EXCHANGING THE PRODUCT...

Please check your owner's manual before exchanging the product. Adjustments of the controls discussed there may save you time and money.

LIMITATION OF LIABILITY AND REMEDY...

MAGNAVOX IS NOT LIABLE UNDER ANY CIRCUMSTANCES FOR ANY DIRECT, INDIRECT, SPECIAL, INCIDENTAL, OR CONSEQUENTIAL DAMAGES, HOWSOEVER INCURRED, EVEN IF NOTIFIED OF THE POSSIBILITY OF SUCH DAMAGES. TO THE EXTENT PERMITTED BY LOCAL LAW, THE REMEDIES PROVIDED IN THIS WARRANTY STATEMENT ARE YOUR SOLE AND EXCLUSIVE REMEDY. THIS LIMITED WARRANTY GIVES YOU SPECIFIC LEGAL RIGHTS, AND YOU MAY ALSO HAVE OTHER RIGHTS WHICH VARY FROM STATE/PROVINCE TO STATE/PROVINCE.

TO EXCHANGE YOUR PRODUCT IN THE U.S.A., PUERTO RICO, OR U.S. VIRGIN ISLANDS...

FOLLOW THE INSTRUCTIONS STATED PREVIOUSLY IN THE "WHAT IS COVERED" SECTION, OR REFER TO THE EXCHANGE INSTRUCTIONS ON THE NEXT PAGE. IN THE U.S.A., PUERTO RICO, AND U.S. VIRGIN ISLANDS, ALL IMPLIED WARRANTIES, INCLUDING THE IMPLIED WARRANTIES OF NON-INFRINGEMENT, MERCHANTABILITY AND FITNESS FOR A PARTICULAR PURPOSE, ARE SPECIFICALLY DISCLAIMED, AND TO THE EXTENT INCONSISTENT WITH LAW OF THE LOCALITY OF THE USER, LIMITED IN DURATION TO THE DURATION OF THIS EXPRESS WARRANTY. BECAUSE SOME STATES DO NOT ALLOW LIMITATIONS ON HOW LONG AN IMPLIED WARRANTY MAY LAST, THIS LIMITATION MAY NOT APPLY TO YOU.

TO EXCHANGE A PRODUCT IN CANADA...

Please contact Magnavox at:

1-800-705-2000

In Canada, this warranty is given in lieu of all other warranties. There are no other warranties, express or implied, including any implied warranties of merchantability or fitness for a particular purpose.

REMEMBER...

Please record below the model and serial numbers found on the product. Also, please fill out and mail your warranty registration card promptly. It will be easier for us to notify you if necessary.

MODEL # _____

SERIAL # _____

This warranty gives you specific legal rights. You may have other rights which vary from state/province to state/province.

Magnavox, P.O. Box 520890, Miami, FL 33152, USA, (402) 536-4171

EL6505E004 / 11-02

EXCHANGE INSTRUCTIONS

To exchange your product with Magnavox (per the warranty conditions stated previously), remember:

- If you exchange the product within 90 days of the original purchase, there is no cost to you.*
- If you exchange the product more than 90 days after but less than one year after the day of original purchase, contact Magnavox at 1-800-705-2000 to determine the preset cost for exchange.
- If you do not have your original sales receipt, or if you have any questions, call Magnavox at 1-800-705-2000.

To obtain a replacement product from Magnavox:

1. Contact Magnavox at 1-800-705-2000 to determine the cost for exchange.
2. Complete the Exchange Form below.
3. Pack the product and its accessories in the original box or a suitable alternative. You will receive replacement accessories with your replacement product. For packing details, call Magnavox at 1-800-705-2000.
4. Put the completed Exchange Form, a copy of the original sales receipt, and the proper payment amount into an envelope. DO NOT SEND CASH. Do not staple or clip these items together. Label the envelope "Return Documents Enclosed." Place this envelope in the box with the product.
5. Seal the box with packing tape and return the product via United Parcel Service (UPS), insured and freight prepaid, to the address provided by Magnavox. For details, call 1-800-705-2000. A replacement will be sent to you via UPS within 48 business hours of Magnavox' receipt of the product.

*When it is necessary for you to ship the product to Magnavox for exchange, you will pay the shipping costs for shipment to Magnavox. Magnavox will pay the shipping costs when returning a product to you.

EXCHANGE FORM

Your Address (street address to which replacement should be delivered, no P.O. boxes allowed):

Name: _____
Street Address: _____ Apt. #: _____
City: _____ State/Province: _____ Zip Code/Postal Code: _____
Phone (day): _____ Phone (night): _____

Exchange Fee: _____ + Sales Tax: _____ = Total: _____

Method of Payment: (Check one. Please, no cash or CODs.)

Check/Money order Check/Money order No. _____

 American Express Account number _____ Expiration date _____
 Visa _____ _____
 Novus/Discover _____ _____
 MasterCard _____ _____

Signature: _____

Detailed reason for return, use additional paper if necessary: _____

Model Number _____ Serial Number _____

Remember, the return box should include the following:

- The product,
- Accessories supplied with the product, and
- Completed Exchange Form and sales receipt,
- Payment, if applicable.

MAGNAVOX
A Division of Philips Consumer Electronics North America
Knoxville, Tennessee 37914-1810, U.S.A
Meet Magnavox at the Internet
<http://www.magnavox.com>

MPD720

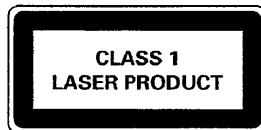

IB8485E001
